

割付図 (S=1:20)

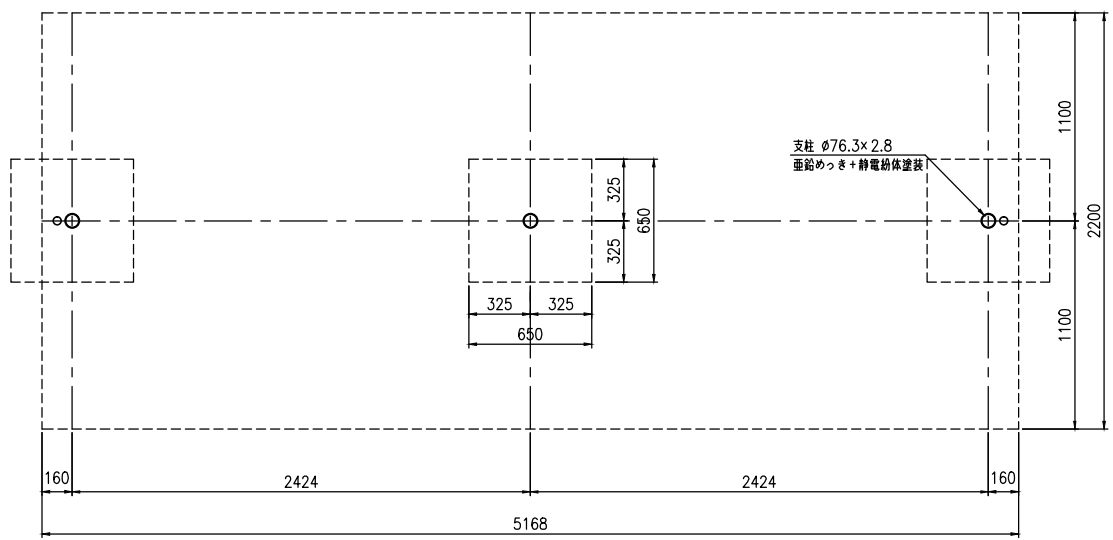

平面図 (S=1:20) (▼印: 屋根葺き位置)

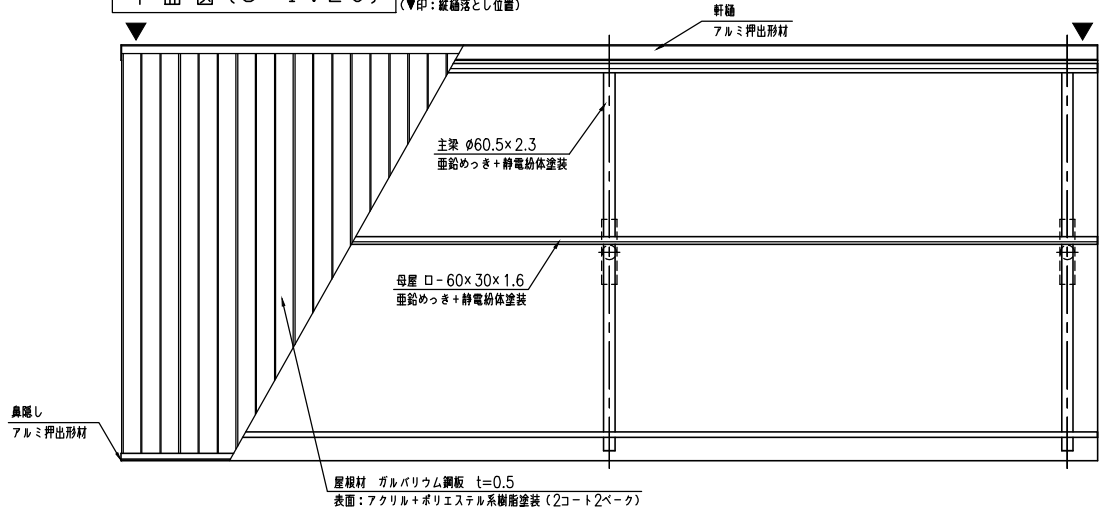

正面図 (S=1:20)

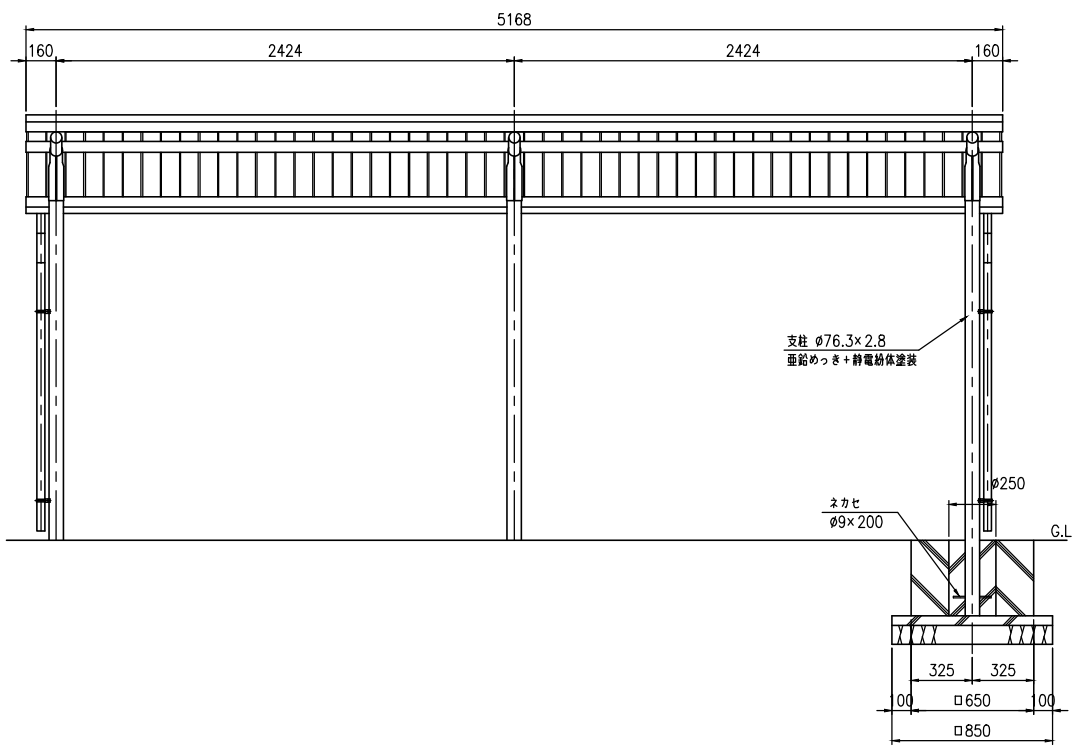

A部詳細図 (S=1:5)

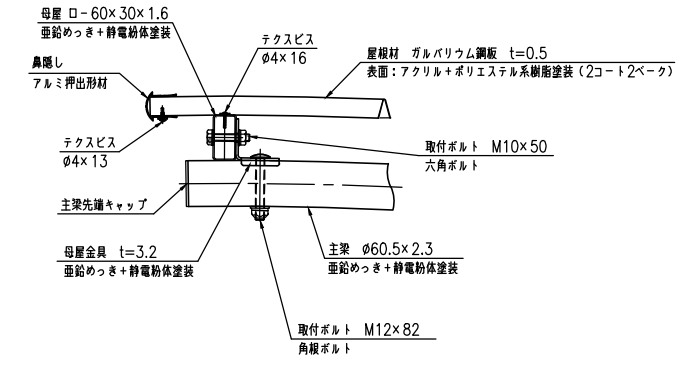

断面図 (S=1:10)

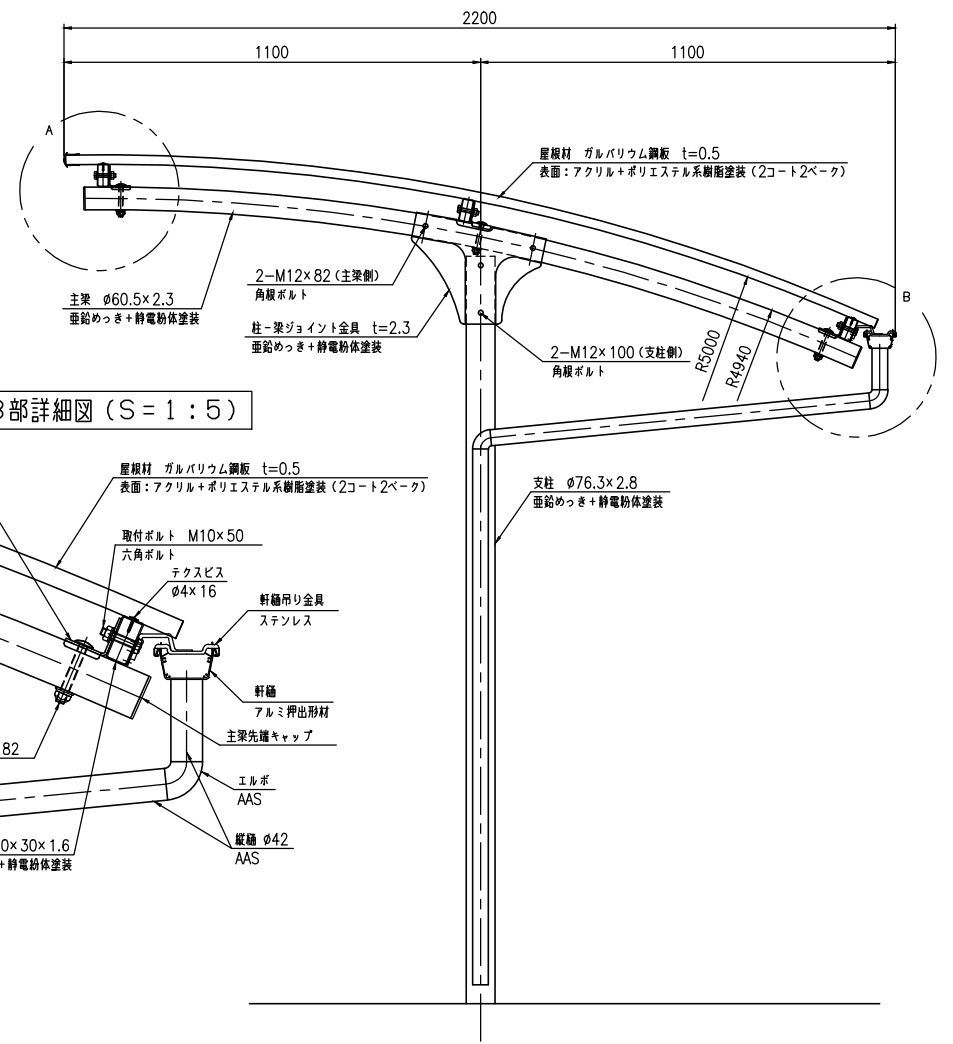

B部詳細図 (S=1:5)

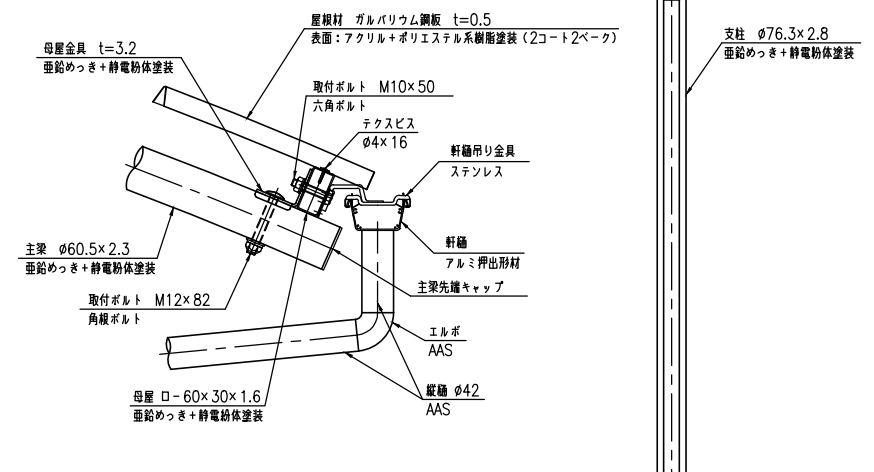

屋根材取付詳細図 (S=1:5)

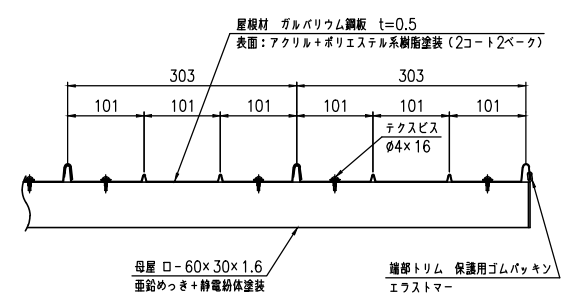

側面図 (S=1:20)

