

C1
(H=600)

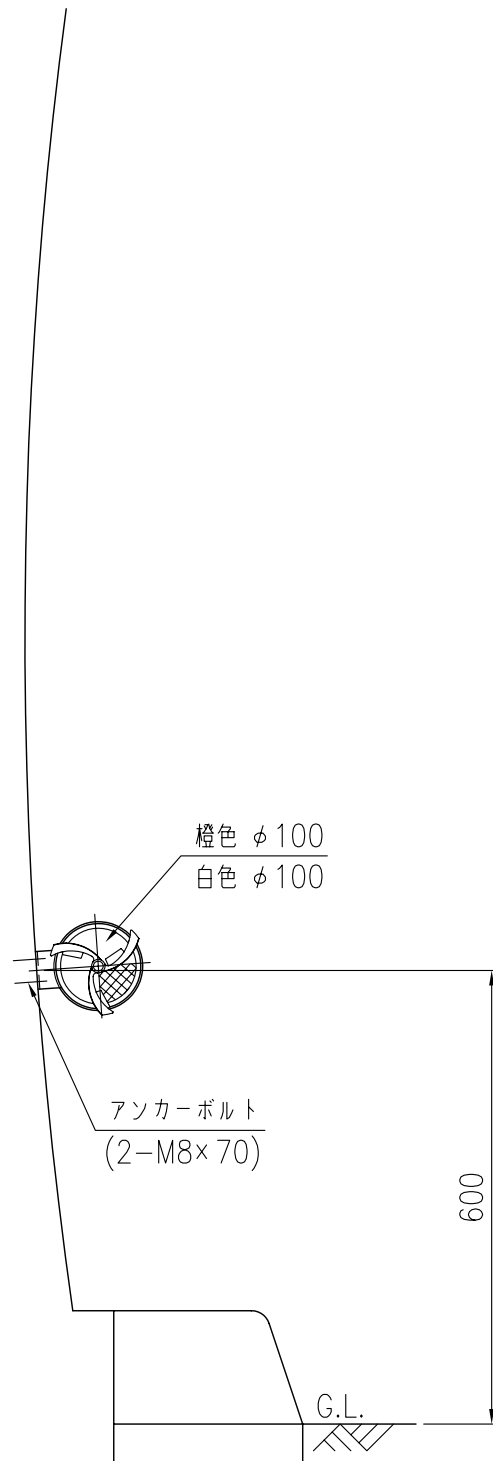

設置図 S=1/10

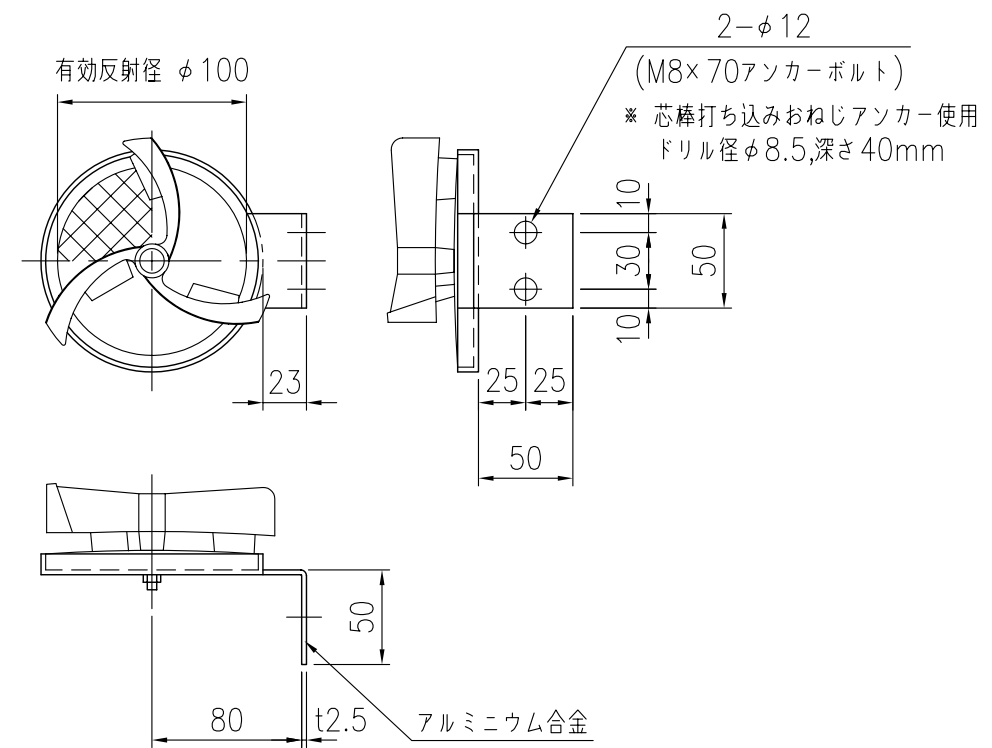

反射部詳細図 S=1/4