

B4-G
(H=1200)

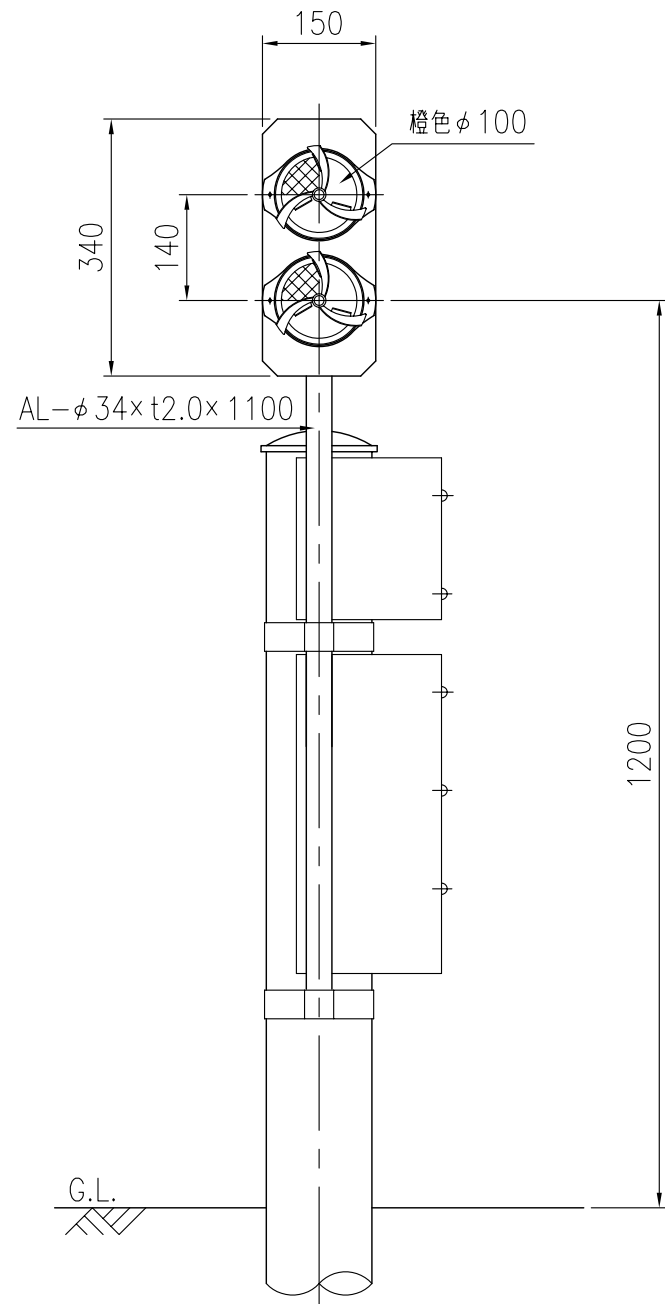

設置図 S=1/10

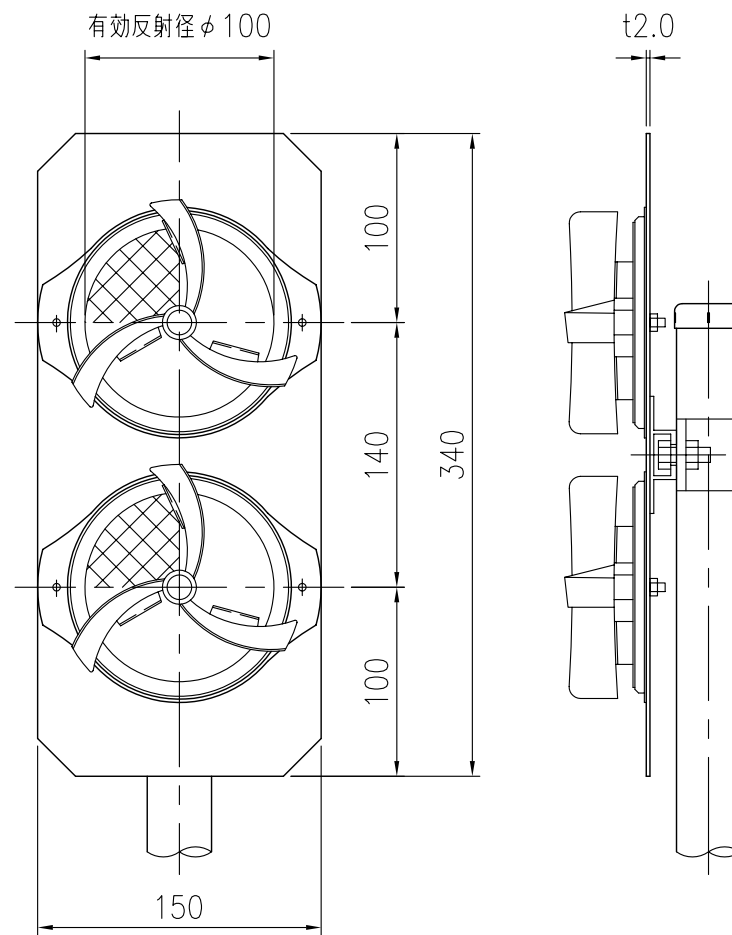

反射部詳細図 S=1/4

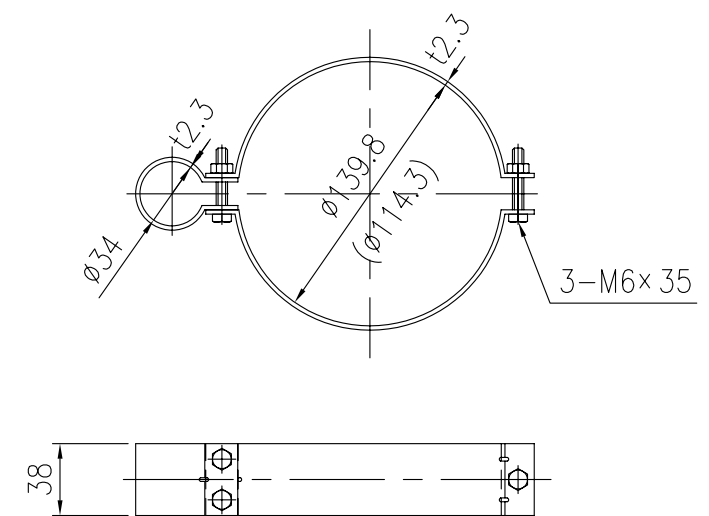

親子バンド詳細図 S=1/4

※ アルミニウム合金