

A4-2  
(H=200)

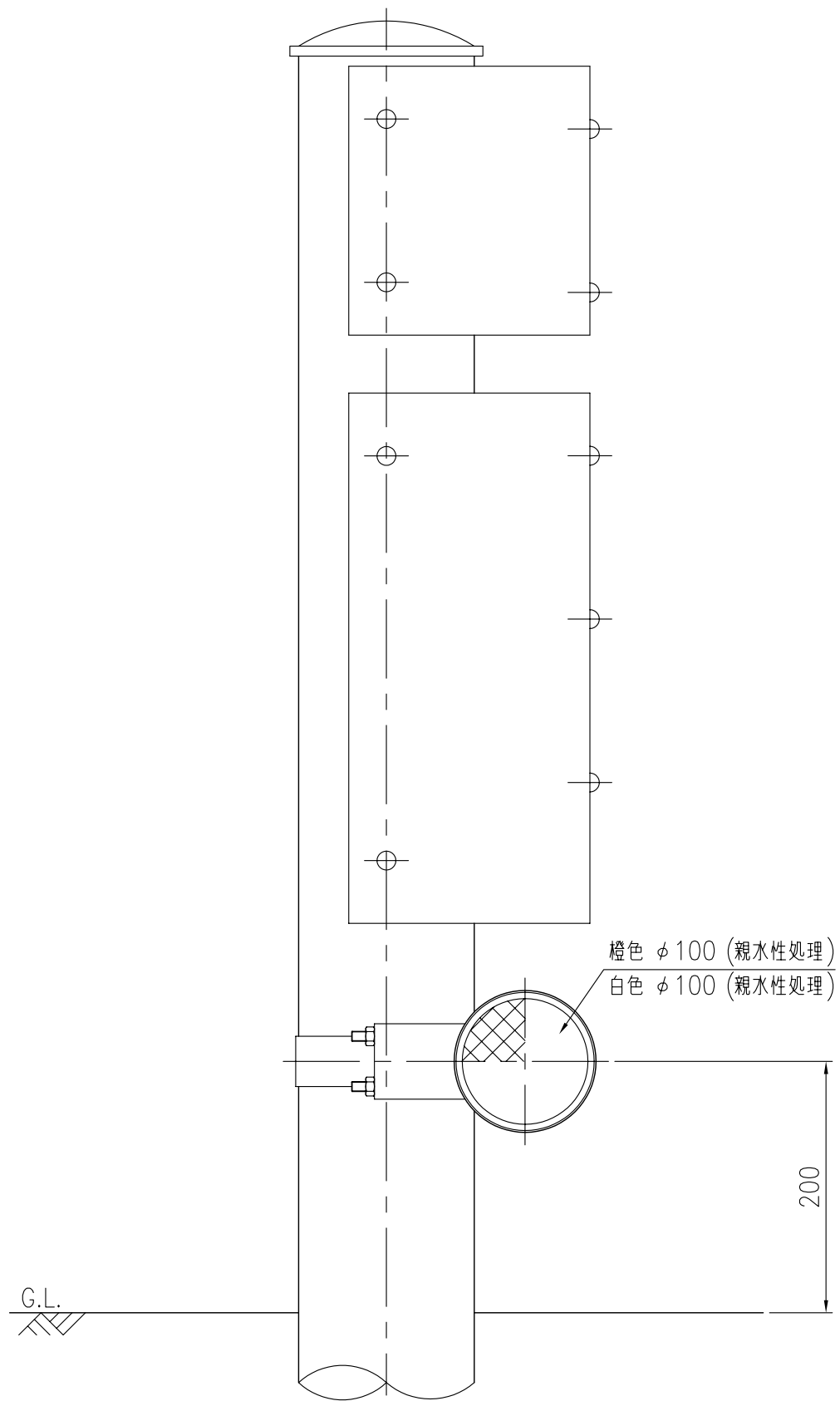

設置図 S=1/5

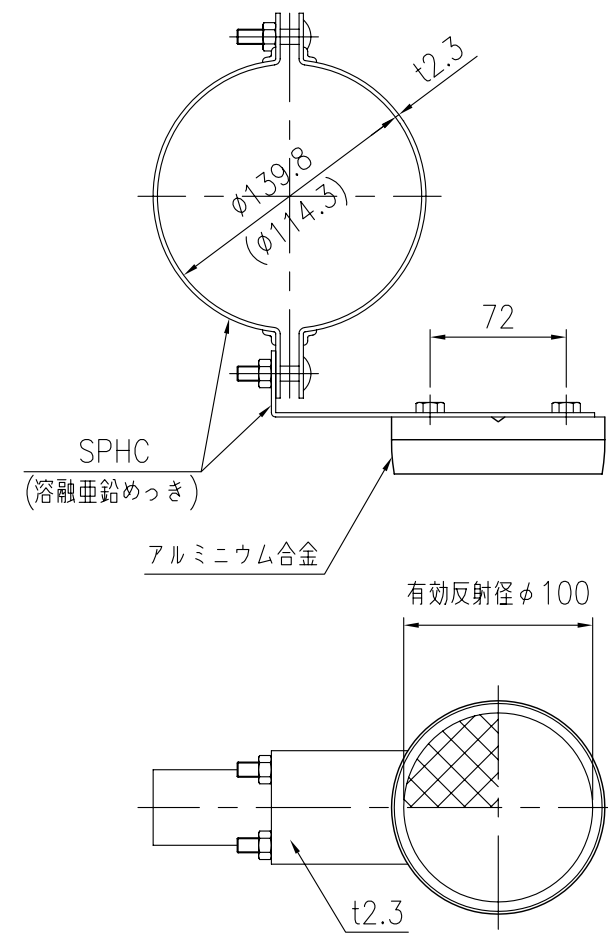
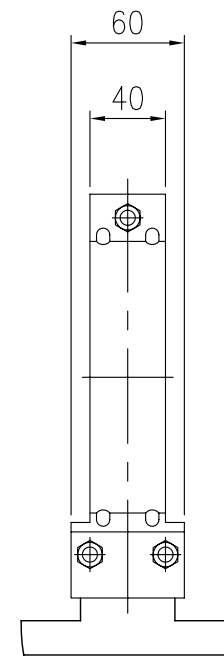

反射部詳細図 S=1/4