

A4-2-G
(H=200)

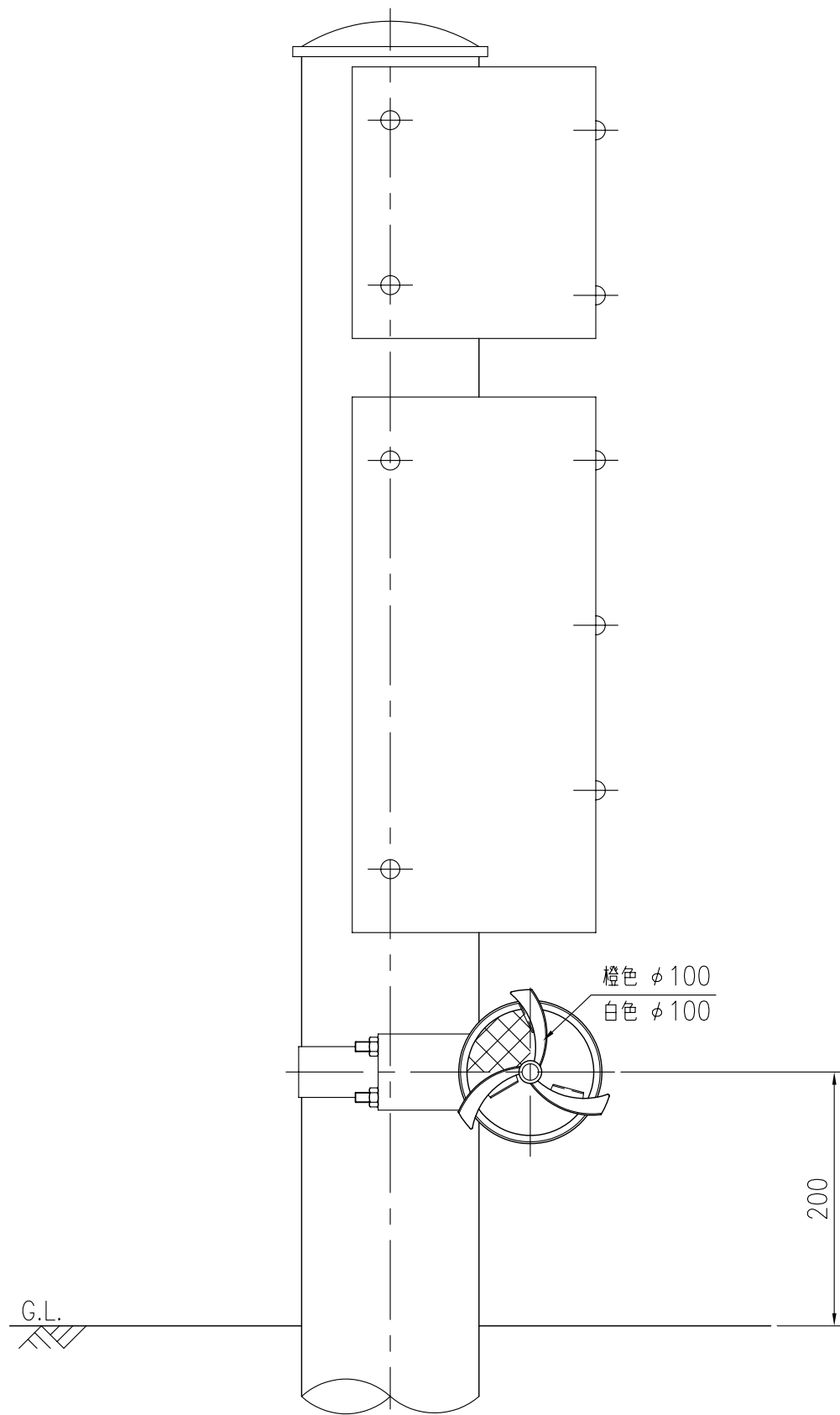

設置図 S=1/5

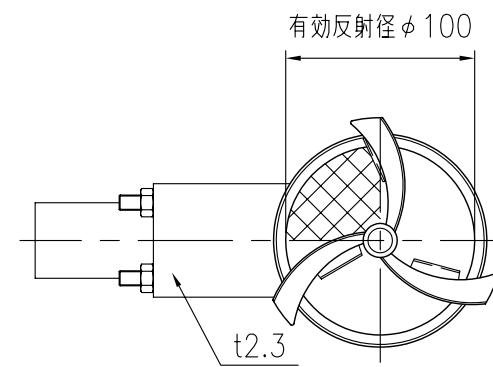
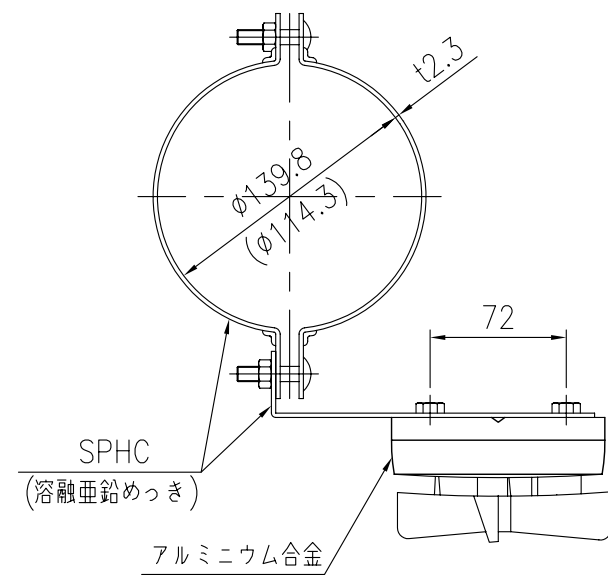
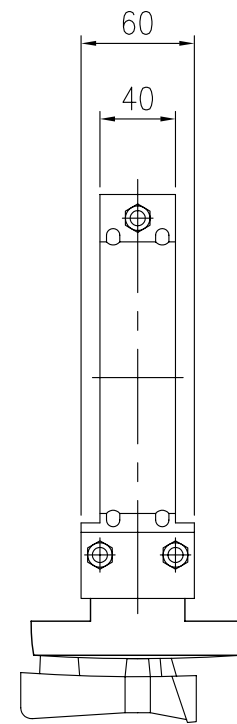

反射部詳細図 S=1/4