

A2-4
(H=200)

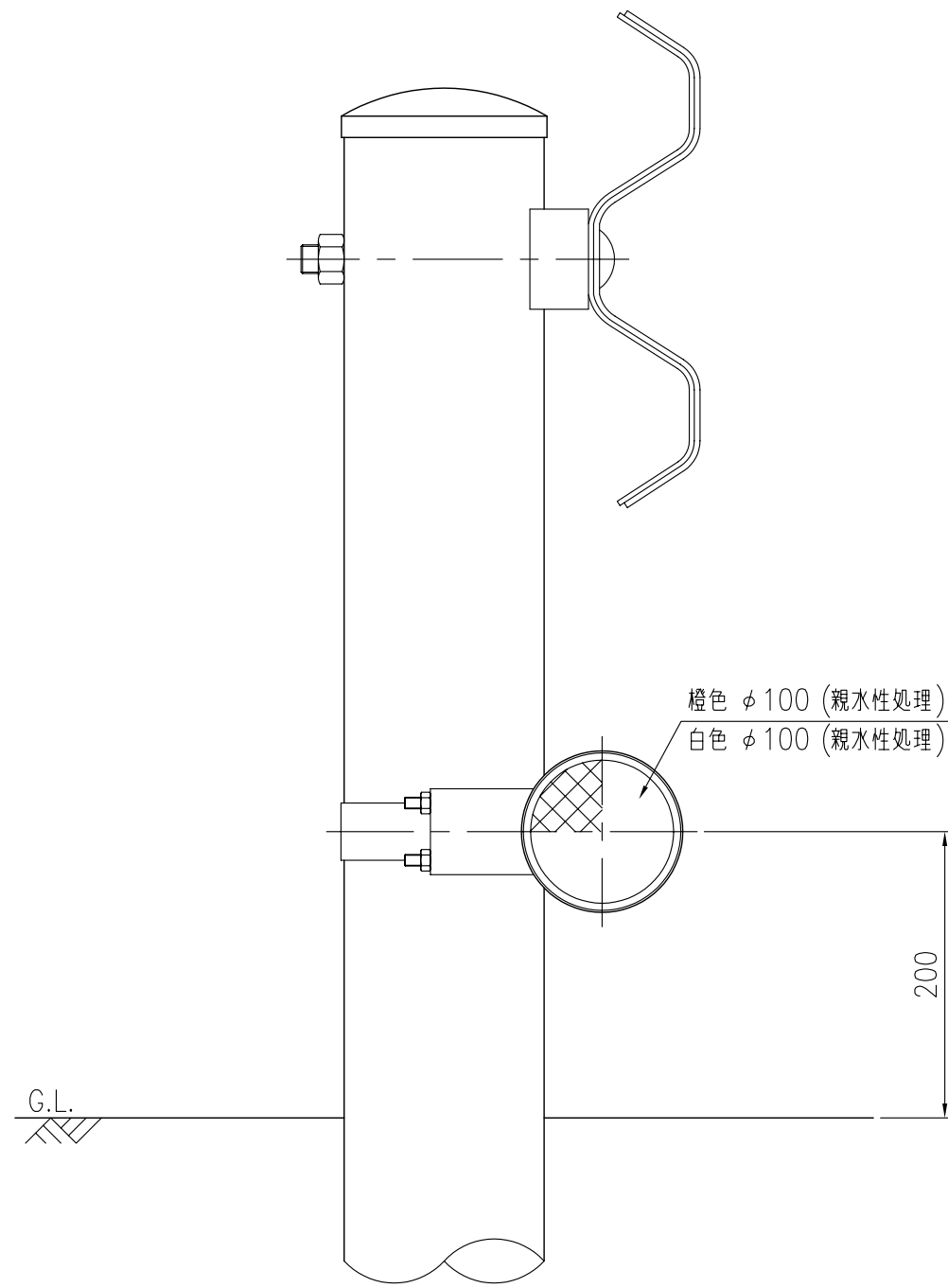

設置図 S=1/5

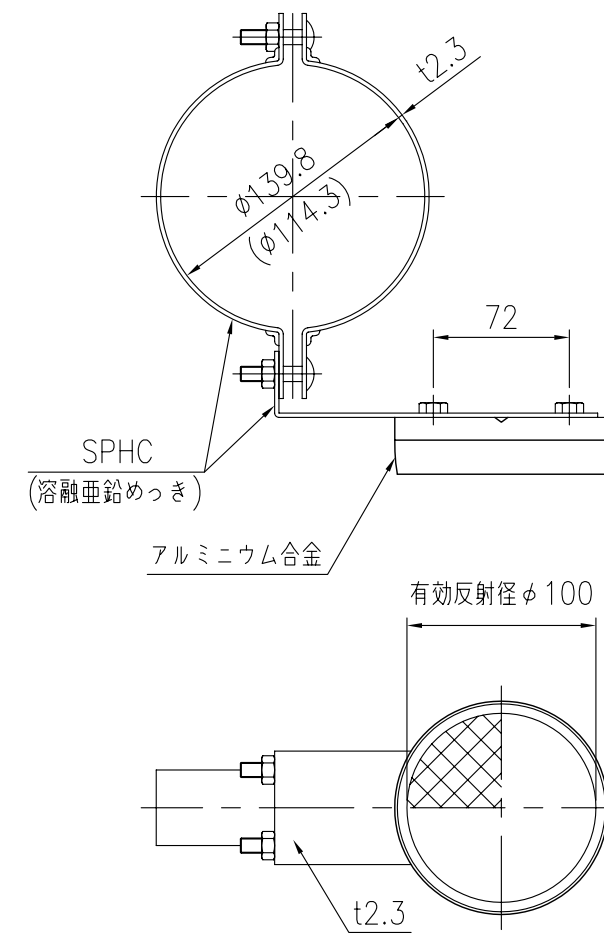
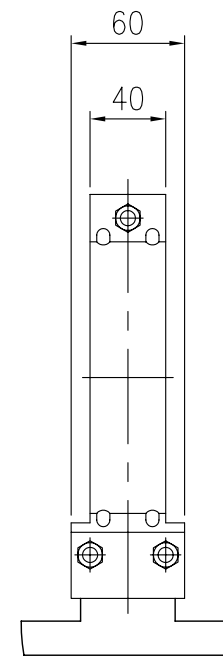

反射部詳細図 S=1/4