

A1-4-G
(H=200)

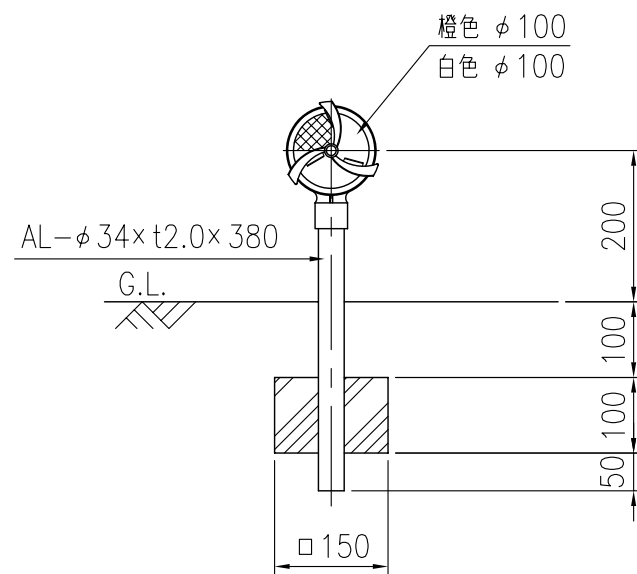

設置図 S=1/10

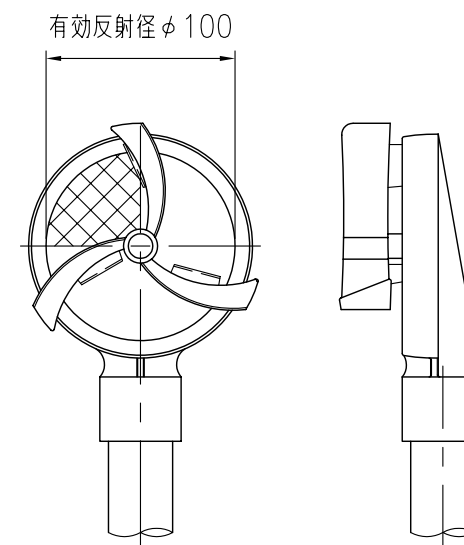

反射部詳細図 S=1/4