

A1-2-G  
(H=900)

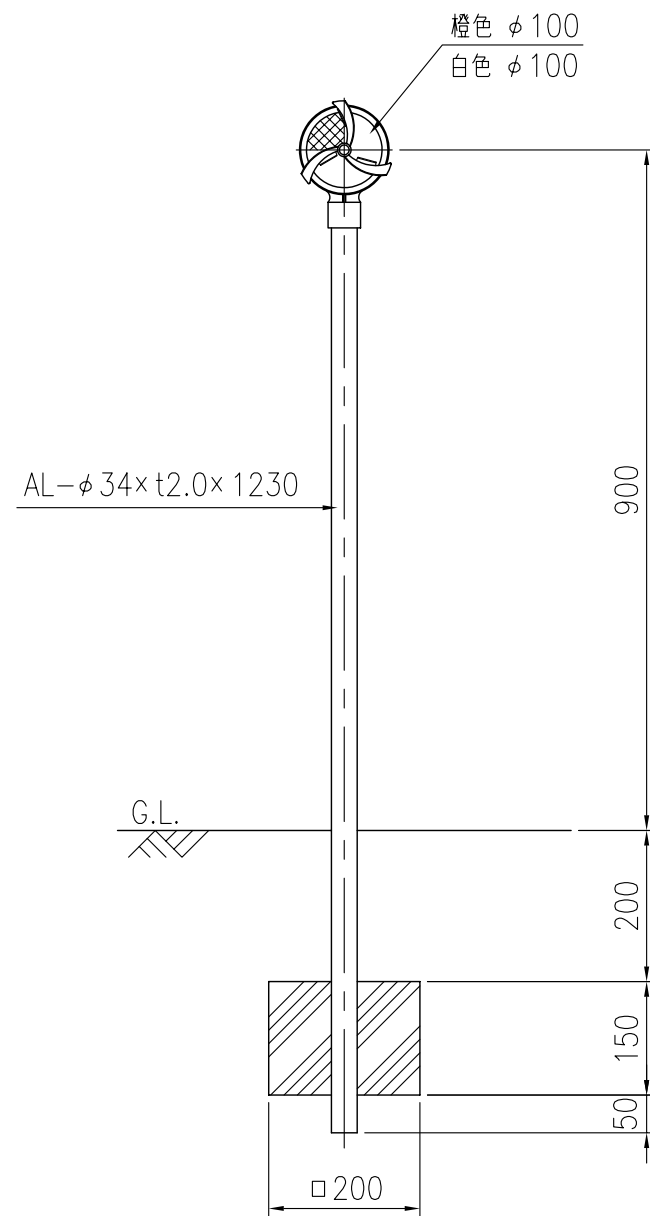

設置図 S=1/10

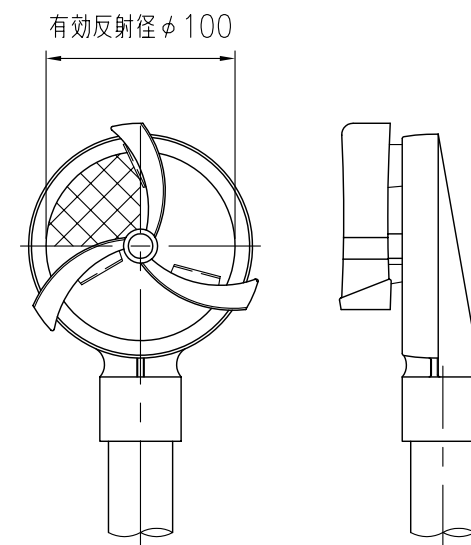

反射部詳細図 S=1/4