

A1-1-G
(H=1200)

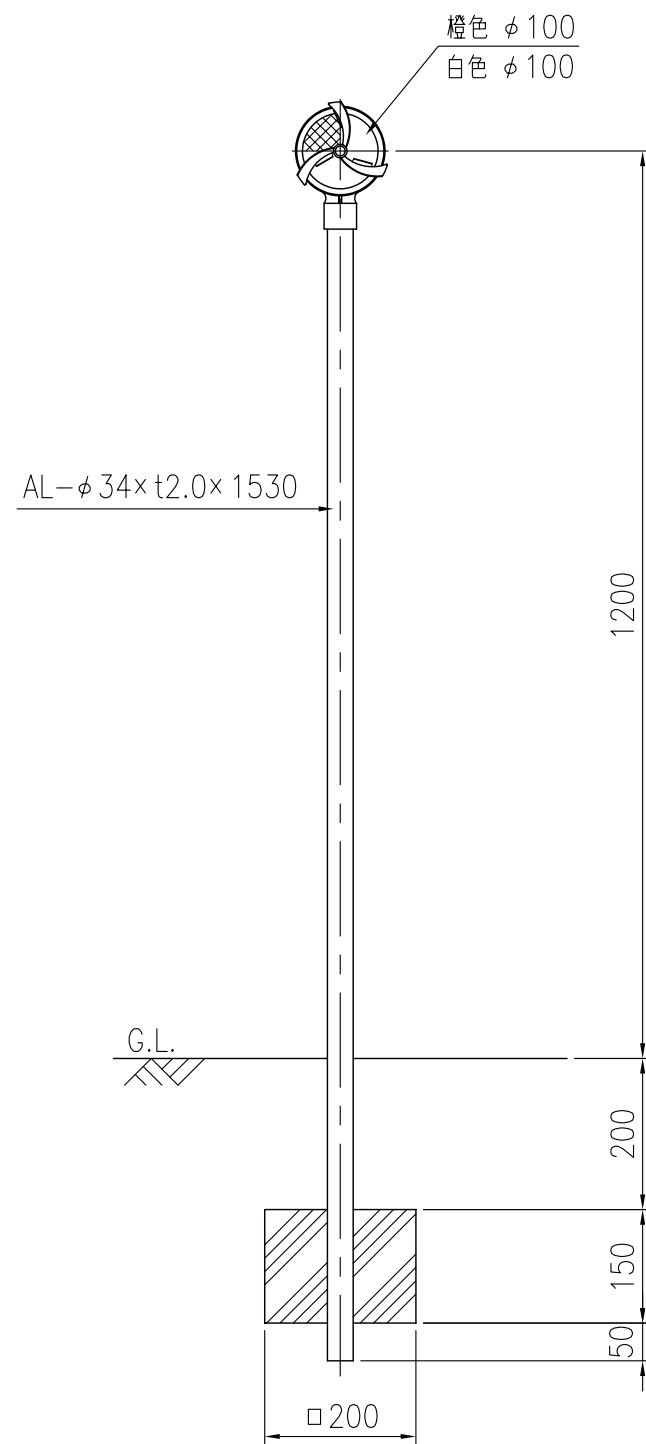

設置図 S=1/10

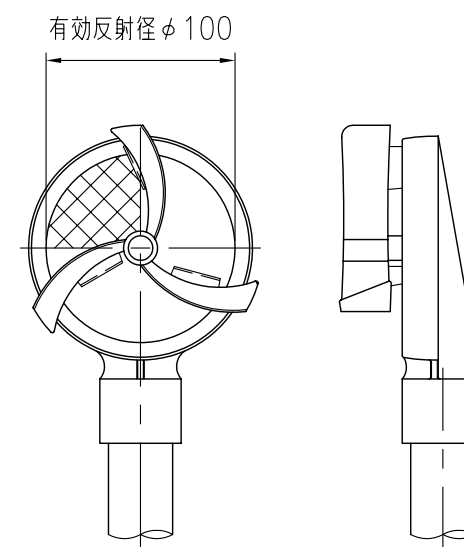

反射部詳細図 S=1/4