

② 支脚 S=1/10

⑦ 回転防止板 S=1/5

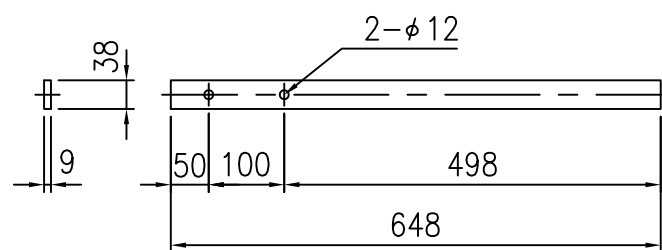
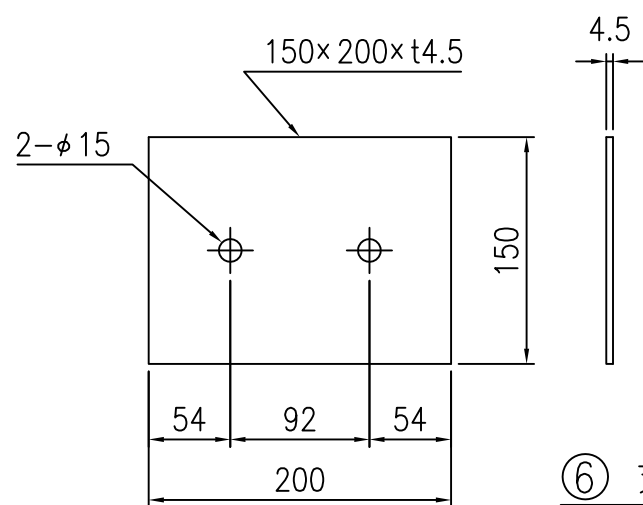

③ 取付金具 S=1/4

④ 金具取付ボルト S=1/2

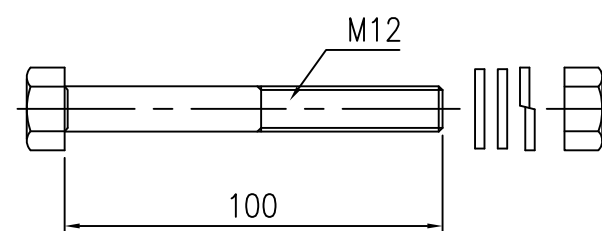

⑤ 脚取付ボルト S=1/2

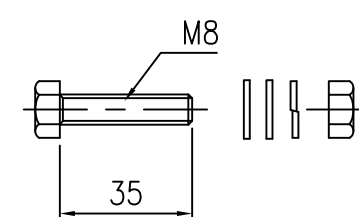

⑥ 支柱 S=1/10

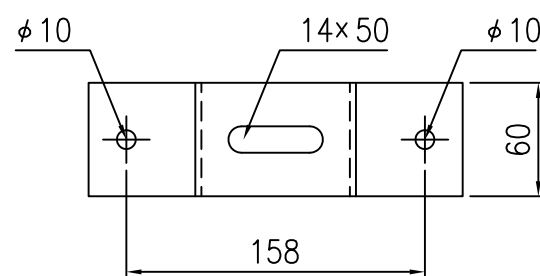
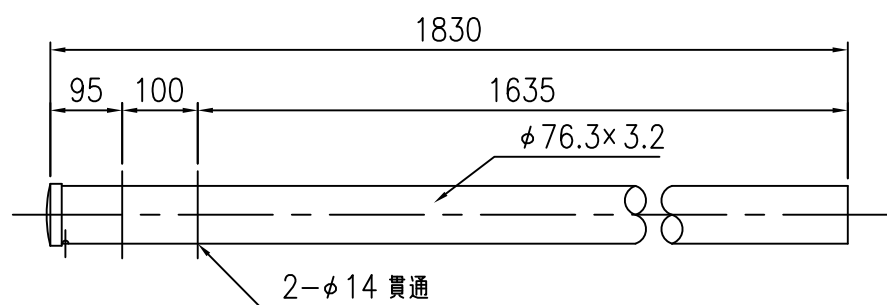

⑧ Uボルト S=1/4

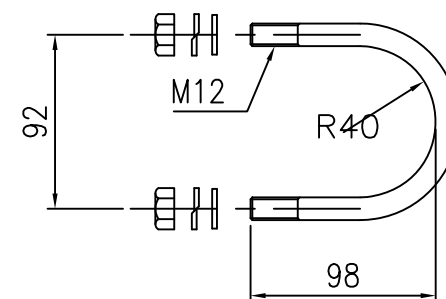

FRP-Bタイプ				
部番	部品名	数量	材質	摘要
1	防眩板	1	FRP	—
2	支脚	2	SS400	HDZ55
3	取付金具	2	SPHC	HDZ55
4	金具取付ボルト	2	4 T相当	HDZ35 平Wx2, Nx1, SWx1
5	脚取付ボルト	4	4 T相当	HDZ35 平Wx2, Nx1, SWx1
6	支柱	1	STK400	HDZ55
7	回転防止板	1	SS400	HDZ55
8	Uボルト	1	—	HDZ35, Nx2 平Wx2, SWx2